

HTL3

Series
Actuators



HTL3

Series

Linear Actuators

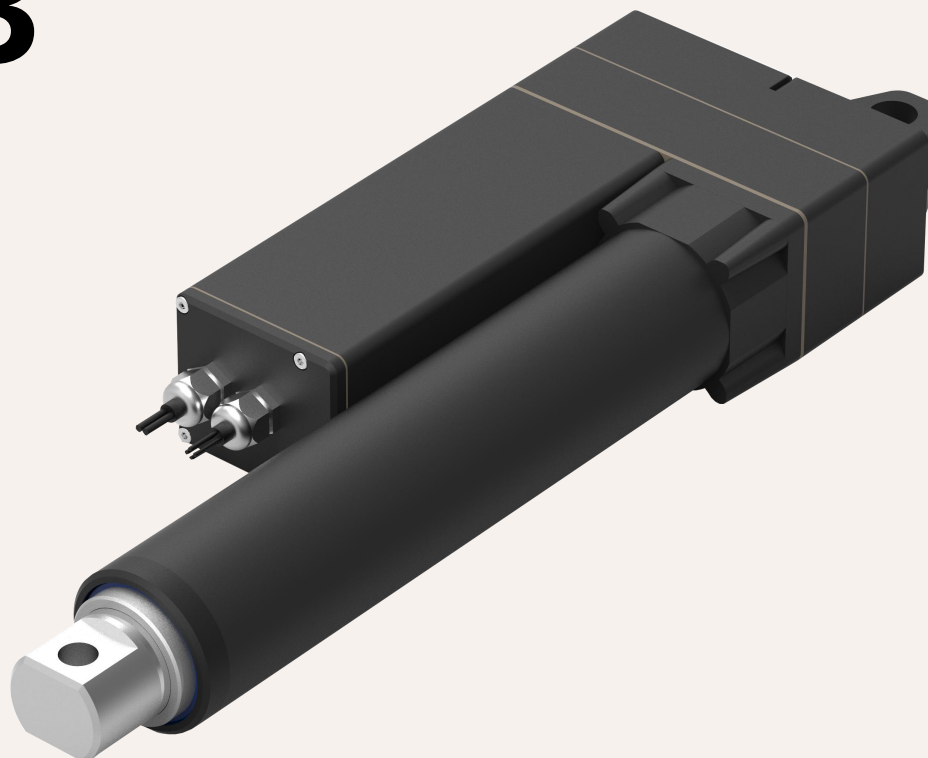

Product Category

- 1、 Industrial application
- 2、 Military application
- 3、 Agricultural machinery

HTL3 multi-stage high load linear actuator is a push rod designed specifically for harsh industrial environments, especially for some mechanical equipment with high wear and tear, such as agricultural machinery and industrial application equipment. If you are looking for a push rod that can be used in harsh industrial environments and must meet strict specifications and standards, the smart electromechanical actuator is equipped with onboard electronics and does not require a separate control system. With higher power up to 9 kN, it opens up more possibilities for hydraulic steering electric applications. HTL will be the best choice!!

Functional Overview

Voltage:	12V, 24V, 36V, 48V DC, 220V AC
Motor options:	DC motor, brushless DC motor, Servo Motor
Maximum thrust (pull force):	9,000N / 9,000N
Slowest speed under load:	7.0mm/s (load 9,000N)
Maximum speed under load:	150 mm/s (load 500N)
Minimum installation size:	Stroke / 2+ 250mm
Dynamic lateral moment:	1,000Nm
Static lateral moment:	800Nm
color:	Silver gray, black
Voice:	60~70 DB
Adaptable temperature range:	-45°C ~ +75°C
Protection level:	IP65
Screw selection:	I ball screw, trapezoidal screw
Switch type:	Built-in limit switch,
Signal options:	Potentiometer, Hall sensor, endpoint signal
Control options:	Synchronous control, independent control,
safety certificate:	integrated control, CAN bus control, Comply with ISO9001-2008, CE and RoHS regulations,
High-strength metal zinc alloy gearbox and housing,	

NEW!

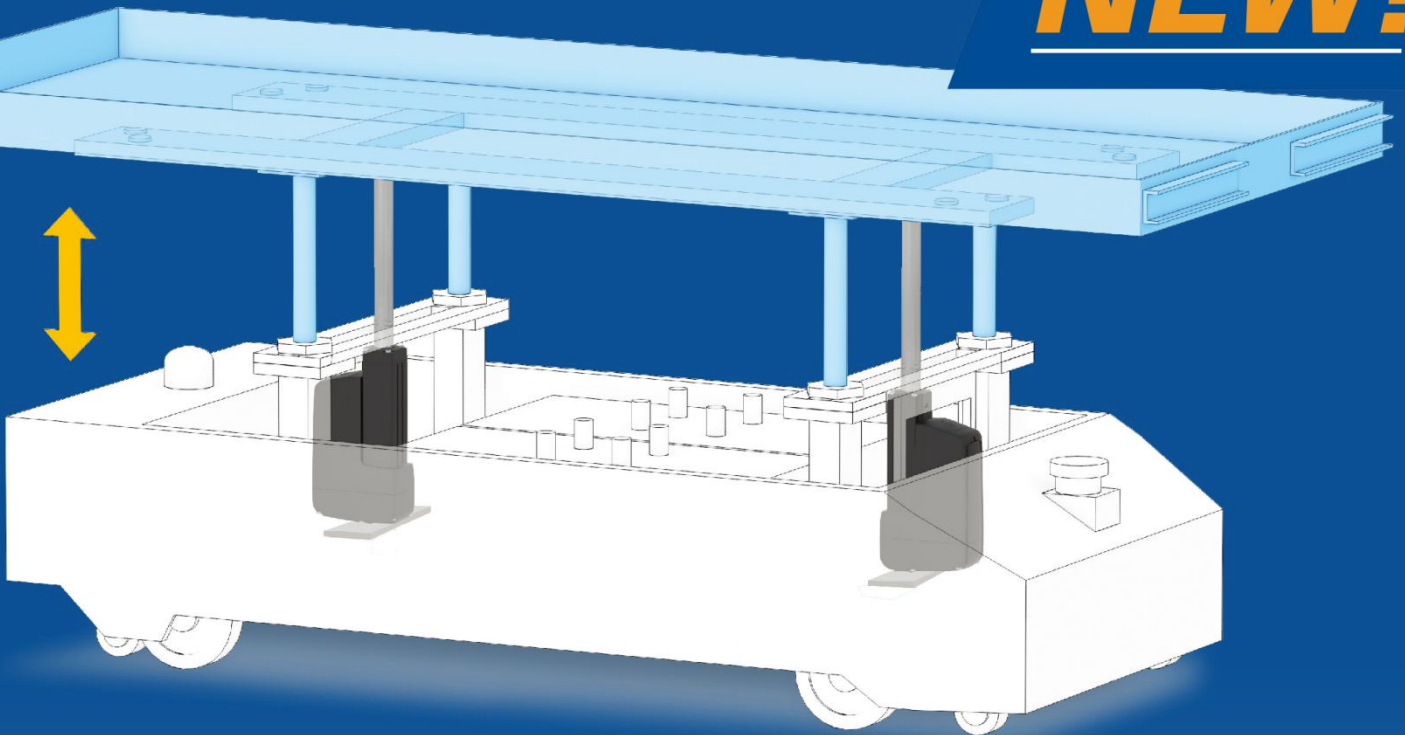

Rear installation can be retrofitted with flange installation

Electric linear actuators for automated guided vehicles, mobile equipment and industrial automation

height adjustment

Positioning adjustment

More compact design,

making it easier to install in small spaces,

Very suitable for designing different types of automation equipment,

unmanned trucks and lifting equipment,

All while retaining many of the benefits that make it so popular!

Drawings

Standard size
MM

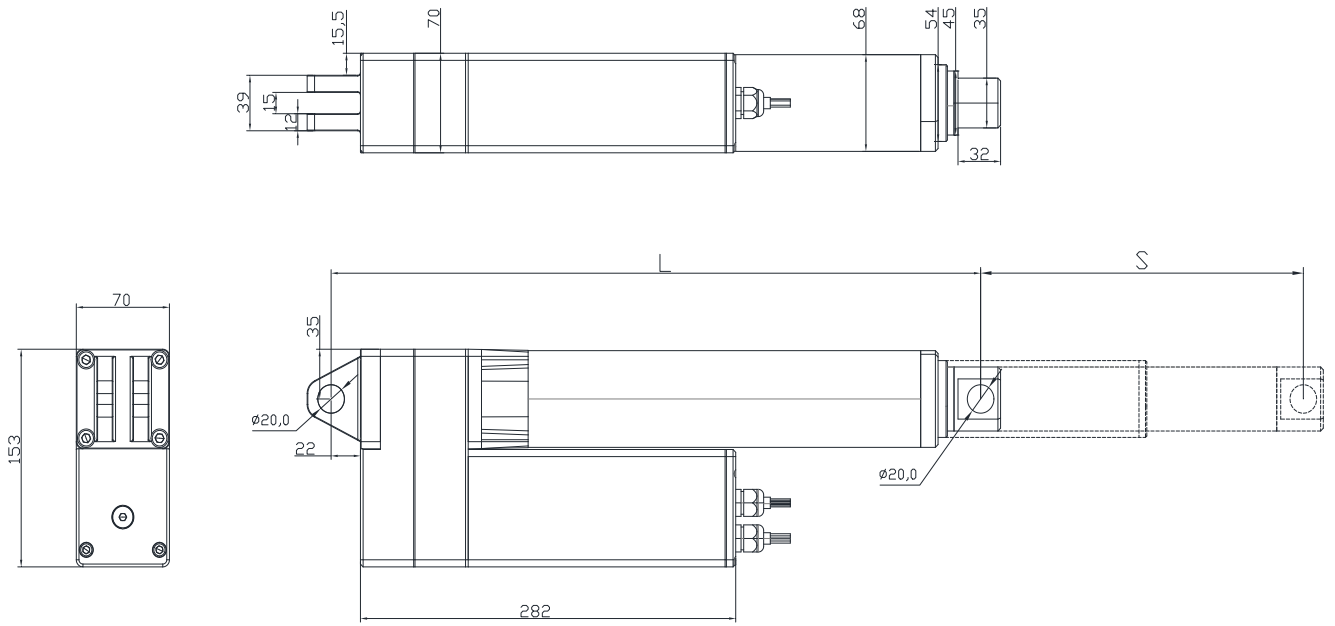

S: Stroke

L: Retracted length

Installation dimensions $L = \text{Stroke} / 2 + 300\text{MM}$

Installation angle (counterclockwise):

0 = 0 Degrees

9 = 90 Degrees

G=Adjust at will

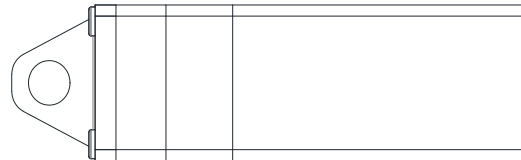
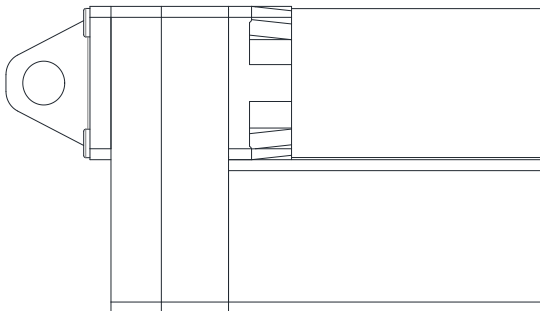

Drawings

Standard size

MM

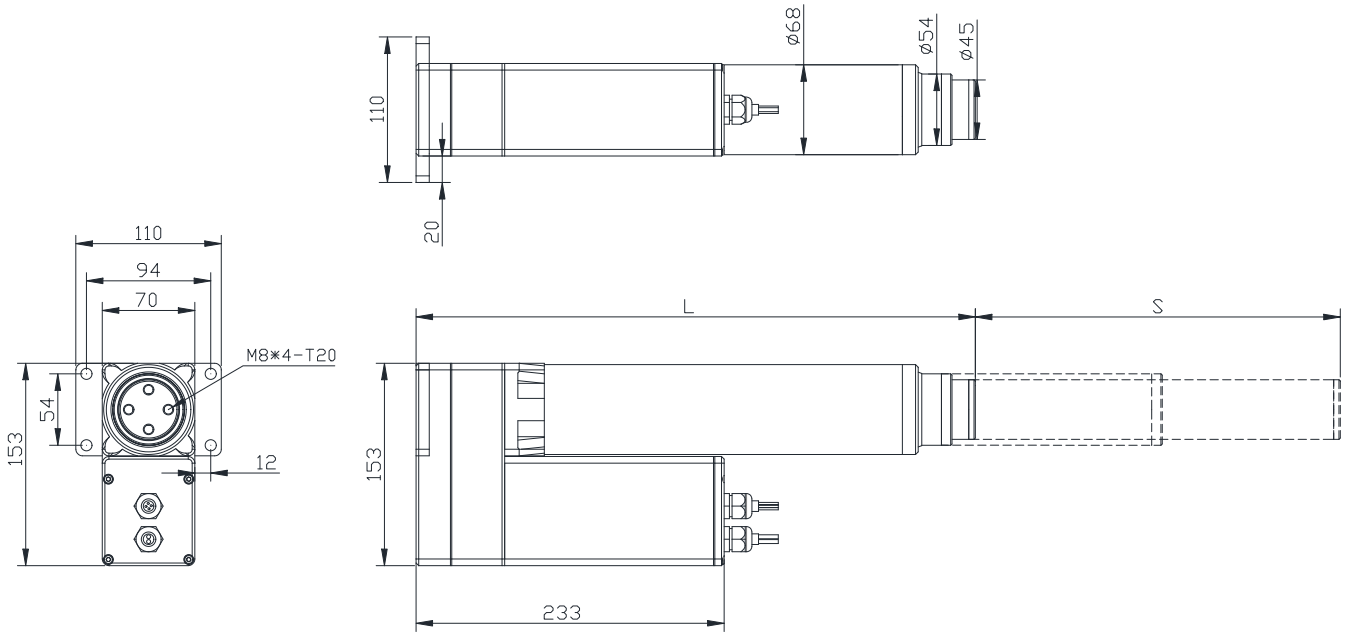

S: Stroke

L: Retracted length

installation dimensions $L = \text{Stroke} / 2 + 250\text{MM}$

Installation angle (counterclockwise):

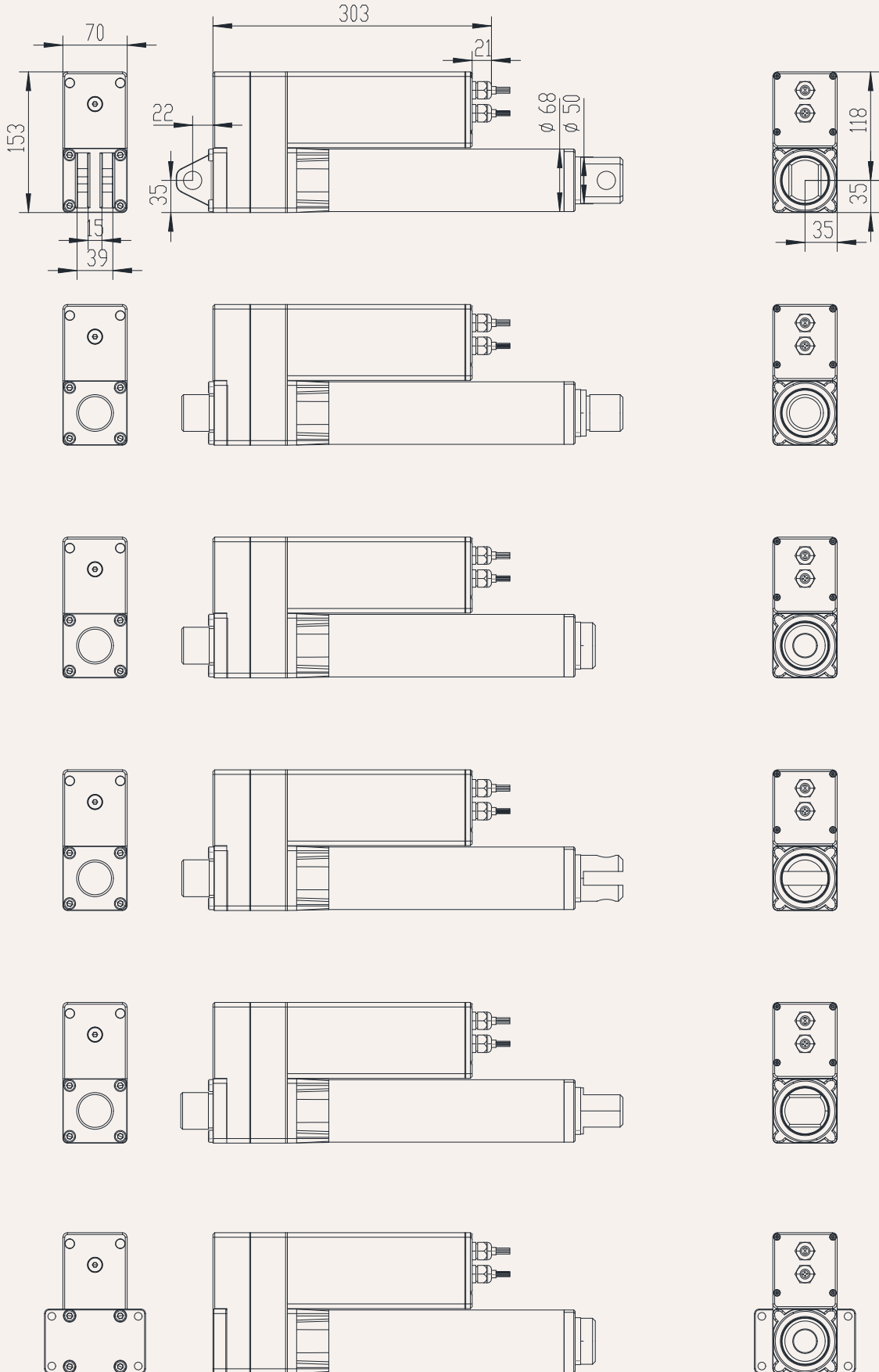

load and speed

Code	Rated load Thrust N	Pull N	Self-locking force static conditions static N	Rated load current A	Output speed no load 24V DC mm/s	Rated load 24V DC mm/s
Motor voltage (24V DC)						
A	9,000	9,000	9,000	17.5	7.0	5.0
B	6,000	6,000	6,000	17.5	11	9.0
C	5,500	5,500	6,000	17.5	13	10
D	4,000	4,000	4,000	17.5	17	13
E	3,300	3,300	3,300	17.5	22	18
F	2,200	2,200	2,200	17.5	33	27
G	1,800	1,800	1,800	17.5	43	34
H	1,100	1,100	1,100	17.5	67	53
I	900	900	900	17.5	75	60
J	500	500	500	17.5	150	120

Remark

1. The speed and current on the upper side are the materials that extend when pushed.
2. For 12V motor, the speed is about the same and the current is about 2 times higher.
3. The current & speed in the table are the test average values in the extension direction under thrust application.
4. The current & speed in the table and graph are the test average values of the GeMinG control box configuration, and there is an error of about 10% depending on the control box model.
(The voltage is about 29V DC at no load, and drops to about 24V DC at rated load)

Stroke: minimum value $\geq 20\text{mm}$, please refer to the table below for the maximum value of load and stroke

load (N)	Maximum stroke (mm)
16,000	50-200
15,000	201-300
12,000	301-400
7,000	401-600
6,000	601-900

Remark:

Lateral moment Y direction = $X \times 0.8$

Static lateral moment = dynamic $\times 2$

Dynamic lateral moment (Nm)-X direction

stroke	S+250	S+300
100-200	200	300
300-500	150	250
500-700	100	200
700-900	80	100

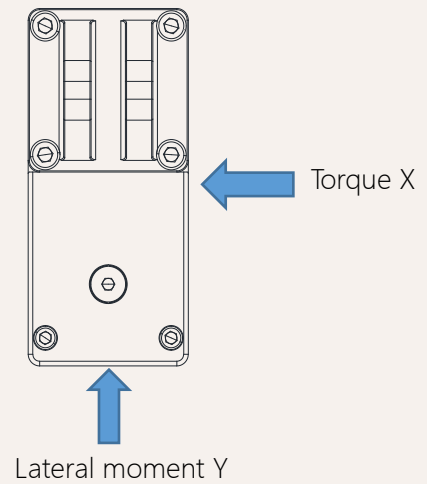

Stroke installation size reference chart

HTL3 Series	stroke ± 2 (mm)					Install ± 2 (mm)				
strokeMM	400	500	600	700	800	900	1000	1200	1300	
Install MM	450	500	550	600	650	700	800	900	950	
weight KG	8.5	9.0	9.5	10.0	10.5	11.0	12.0	15.0	17.0	

Actuator wiring diagram

No signal feedback wiring diagram

Code: N

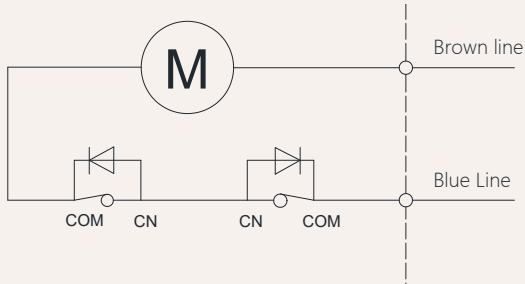

Wiring Instructions:

- 1] Brown lead: motor positive +
- 2] Blue lead: motor negative pole -
- 3] When the push rod is extended: the brown wire is positive +, the blue wire is negative -
- 4] When the push rod is retracted: the blue line is positive +, the brown line is negative -

Signal feedback An electrical signal & No electrical signal

Passive or active endpoint signal wiring diagram

Code: N passive signal, Code: Y active signal

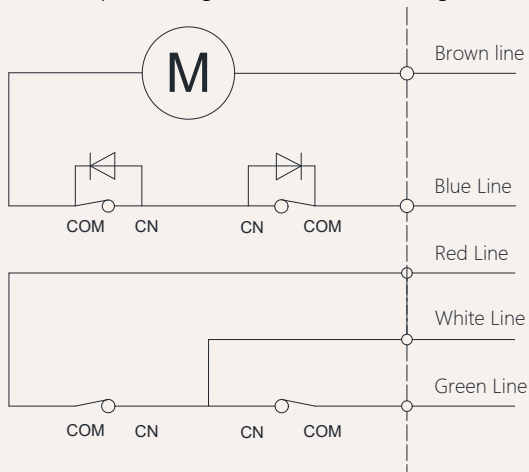

Wiring Instructions:

- 1] Brown lead: positive pole of motor +
- 2] Blue lead: negative pole of motor -
- 3] When the push rod is extended: brown wire positive pole +, blue wire negative pole -
- 4] When the push rod is retracted: blue wire positive pole +, brown wire negative pole -
- 5] White wire: signal output common line.
- 6] White and red wire: extension end signal,
- 7] White and green wire: retraction end signal,

Other signal descriptions

Feedback signal

Description

Function

An electrical signal endpoint feedback signal

Voltage with this model

When the push rod reaches the end point, a signal will be fed back. This signal will always exist and will disappear during the operation of the push rod.,

No electrical signal endpoint feedback signal

No voltage

When the push rod reaches the end point, it will feedback a signal. This signal always exists when the input power is not turned off. When the input power is turned off, the signal disappears. The signal will also disappear during the operation.

Note: For other needs, please contact the GeMinG team

Actuator wiring diagram Built-in control module

Built-in controller wiring diagram

Code: NY

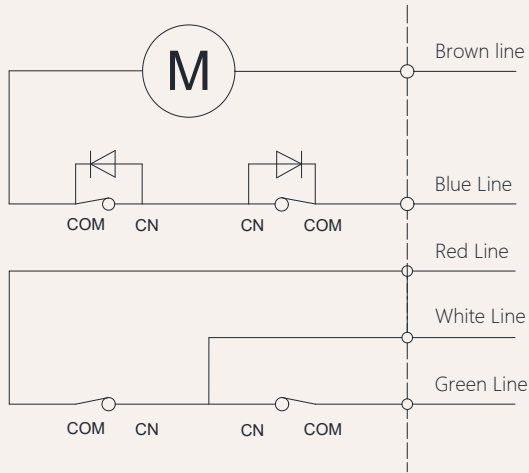

Wiring Instructions:

- 1] Brown lead: motor positive +
- 2] Blue lead: motor negative pole -
- 3] When the push rod is extended: white line + red line
- 4] When the push rod retracts: white line + green line
- 5] White line: control output common line.
- 6] White and red lines: stretch out,
- 7] White and green lines: retract,
- 8] Wireless remote control, use wired control simultaneously.

Signal feedback Potentiometer

Potentiometer wiring diagram

Code: K

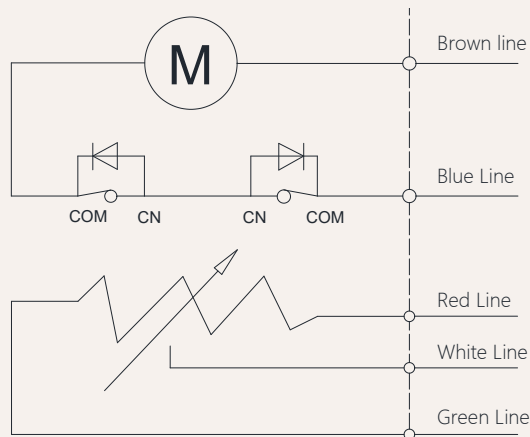

Wiring Instructions:

- 1] Brown lead: positive pole of motor +
- 2] Blue lead: negative pole of motor -
- 3] When the push rod is extended: brown wire positive pole +, blue wire negative pole -
- 4] When the push rod is retracted: blue wire positive pole +, brown wire negative pole -
- 5] White and yellow leads: variable resistance signal output.
- 6] When the push rod is extended: red and white leads-resistance value gradually increases, -----red and yellow leads-resistance value gradually decreases.
- 7] When the push rod is retracted: red and white leads-resistance value gradually decreases, -----red and yellow leads-resistance value gradually increases.

Potentiometer Configuration Form

Transmission Code

Limit travel range

Resistance range unit (KΩ)

(See page 5)

A,C,E,G

50-350MM

50-200Stroke range5.0

50-300Stroke range7.5

B,D,F

50-550MM

50-200Stroke range3.17

50-400Stroke range6.35

Note: Potentiometer resistance is 10KΩ, actual output resistance depends on specific stroke

Signal feedback **Hall sensor**

Hall signal motor circuit diagram

Code: H

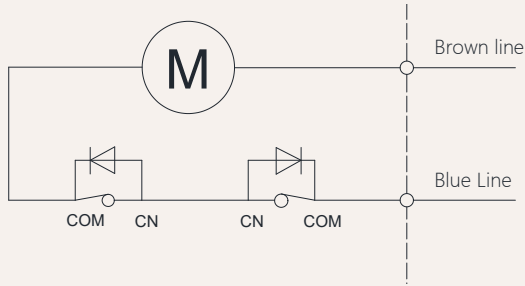

Hall signal output waveform diagram

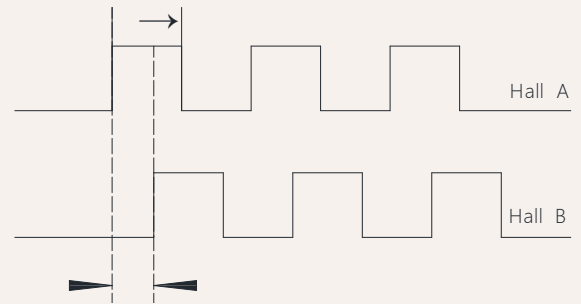

Schematic diagram of the internal circuit of the Hall signal

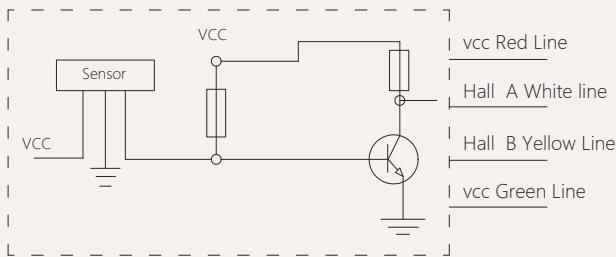

Wiring Instructions:

- 1] Brown lead: positive pole of motor +
- 2] Blue lead: negative pole of motor -
- 3] Red lead: VCC 5V voltage input +
- 4] Green lead: GND 5V voltage input -
- 5] White lead: Hall signal output A
- 6] Yellow lead: Hall signal output B

Notes:

- 1) Support dual-channel/single-channel Hall encoder
- 2) Current-consuming digital output
- 3) High-speed response frequency from: 0 KHz-100 KHz
- 4) Applicable temperature range:-40 °C~+125 °C

Characteristics	Symbol	Test conditions	MI	RE	M	Unit
Supply voltage	Vcc	----	3.5	---	24	V
Output saturation voltage	Vce/sat	Vcc=14V ; Ic=20mA	---	300	700	MV
Output leakage current	1 cex	Vce=14V ; Vcc=14V	---	<0	10	UA
Input voltage	1 ce	Vcc=20V ; Output open	---	1	10	M
Output fall time	R	Vcc=14V ; RL=820Ω ; CL=20pF	---	0.3	1.5	US

Signal feedback CAN bus

CAN Communication motor circuit diagram

Code: CN

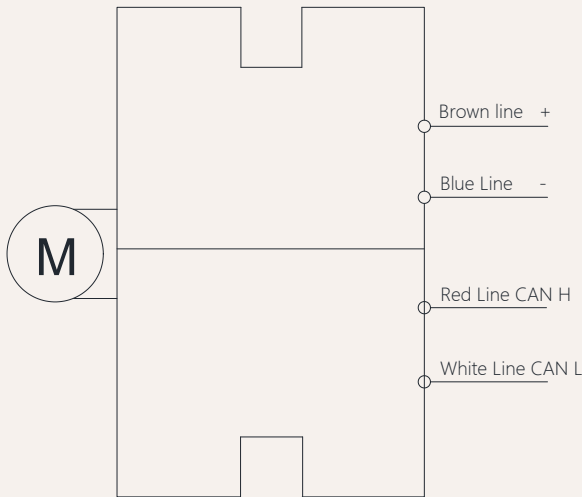

Wiring Instructions:

- 1] Brown lead: positive pole of motor +
- 2] Blue lead: negative pole of motor -
- 3] Red lead: CAN H
- 5] White lead: CAN L

Note:

1. The brown\blue power cord cannot be reversed, otherwise the driver may be burned.
2. With CAN bus, excluding terminal resistor: compliant with J1939
3. Speed: Baud rate: 500kbps

Communication wiring: shielded twisted pair
Cable impedance: 120Ω (+10%)

CAN Control instructions

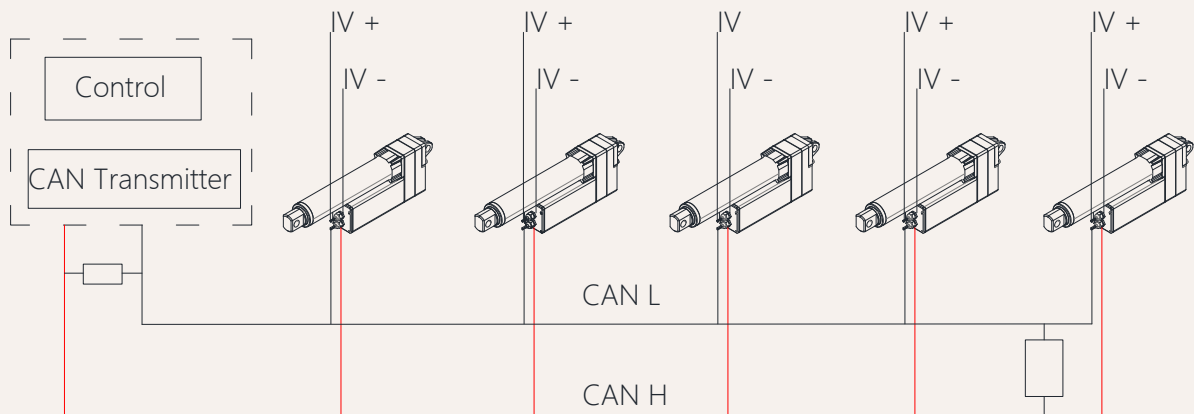

Signal feedback Port Control

Schematic diagram of port control motor circuit

Code: Y

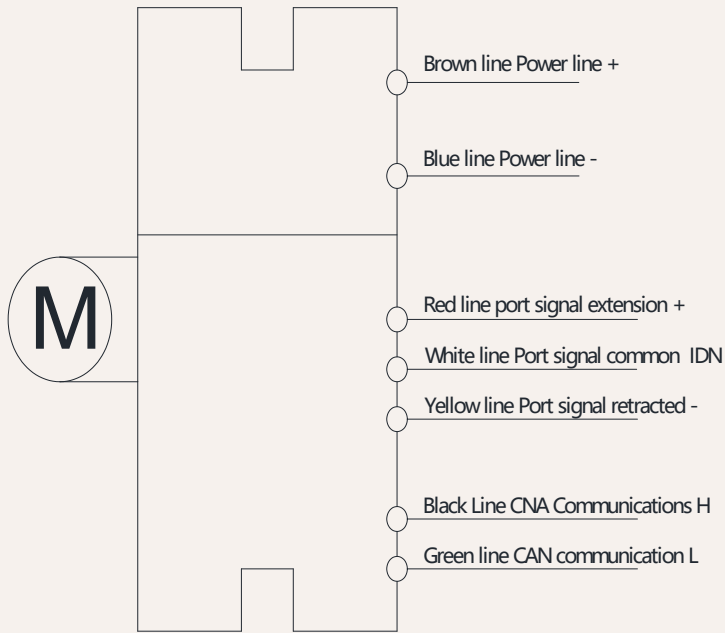

Wiring Instructions:

- 1] Brown lead: Power supply positive (+)
- 2] Blue lead: Power supply negative (-)
- 3] Red lead: Port signal extended (+)
- 4] White lead: Port signal common (IDN)
- 5] Yellow lead: Port signal retracted (-)
- 6] Black lead: CAN communication (H)
- 6] Green lead: CAN communication (L)

Note:

1. Do not connect the brown and blue power cables in reverse, as this may damage the driver.
2. CAN bus included, does not include termination resistors; complies with J1939.
3. Speed: Baud rate: 500kbps

Communication wiring: Shielded twisted pair
Cable impedance: 120Ω (+/-10%)

CAN Control instructions

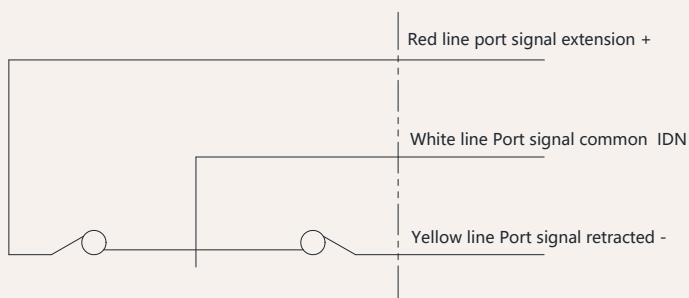

- 1] When the push rod is extended: Red and white leads indicate the push rod is extended.
- 2] When the push rod is retracted: Yellow and white leads indicate the push rod is retracted.

HTL3 Model Description Selection Code Table

HTL3 - 24 A *** *** - O1 O1 0 1 T A N 07
 ① ② ③ ④ ⑤ ⑥ ⑦ ⑧ ⑨ ⑩ ⑪ ⑫ ⑬

①	Product number	HTL3											
②	Voltage	24=24V DC			36=36V DC			48=48V DC			22=220V AC		
③	Load(n)@Speed (mm/s)	See page 06											
④	Stroke(mm)	See page 06											
⑤	Installation size(mm)	Note: Before selecting a size, please refer to the valid data sheet! See page 05											
⑥	Upper type See page 13	O1 = Ordinary type, hole diameter 20.5mm U1 = groove width 15.5mm, hole diameter 20.5mm M1 = Type M, M25 thread, depth 20 mm T1 = T-type, M25 thread, length 20mm L1 = L shape, width 25mm, aperture 20.5mm G1 = Spherical bearing, bore 20mm, model GS20				O2 = Ordinary type, hole diameter 25.5mm U2 = Groove width 1.5mm, hole diameter 25.5mm M2 = Type M, M30 thread, depth 20 mm T2 = T-type, M30 thread, length 20mm L2 = L shape, width 30mm, aperture 25.5mm G2 = Spherical bearing, bore 25mm, model GS25							
⑦	lower type See page 14	O1 = Ordinary type, hole diameter 20.5mm P1 = Flat surface mounting				O2= Ordinary type, hole diameter 22.5mm KZ = Customized							
⑧	Installation angle (counterclockwise)	0 =0°, Degree						9 =90°, Degree					
⑨	Please refer to the outlet type	1 = 12-core bare wire 7 = 12-core, 15-core bare wire 4 = 4-pin straight plug 0 = Customized			5 = 15-core bare wire 2 = OI plug 9 = 6-pin straight plug			6 = 16-core bare wire 3 = 4-pin angled plug 8 = Waterproof plug					
⑩	Lead screw options	G=Ball screw (default preferred)						T = Trapezoidal screw					
⑪	Control method	A = No control T = Synchronous control		C = CAN bus D = Customized		Y =Integrated wired control			N=Integrated wireless control				
⑫	Signal output options	N = None W=passive signal		H = Hall sensor AN = CAN communication		D = Potentiometer signal			U=active signal				
⑬	Cable length	07 =Cable length 0.7 M 30 =Cable length 3.0 M 70 =Cable length 7.0 M		10 = Cable length 1.0 M 40 =Cable length 4.0M 70 =Cable length 8.0 M		15 =Cable length 1.5 M 50 =Cable length 5.0 M 90 =Cable length 9.0 M			20= Cable length 2.0 M 60= Cable length 6.0M 00 =Customization				

HTL3 Attachment Description Selection Code Table

Upper end form (extended):

O1=Ordinary type, hole diameter 20.5mm

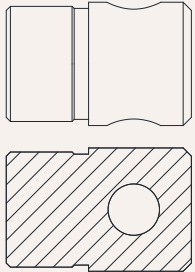

O2=Ordinary type, hole diameter 25.5mm

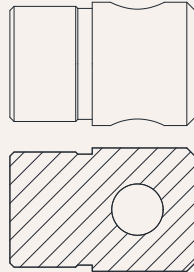

U1 = groove width 15.5mm, hole diameter 20.5mm

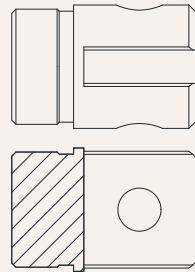

U2 = groove width 15.5mm, hole diameter 25.5mm

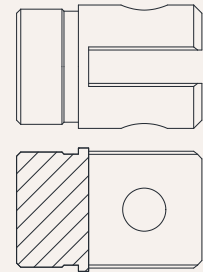

M1 = Type M, M25 thread, depth 20 mm

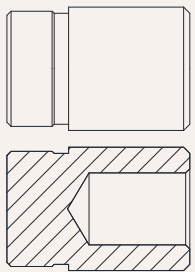

M2 = Type M, M30 thread, depth 20 mm

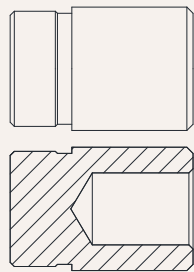

T1 = T-type, M25 thread, length 20mm

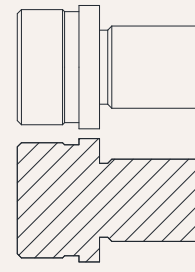

T2 = T-type, M25 thread, length 20mm

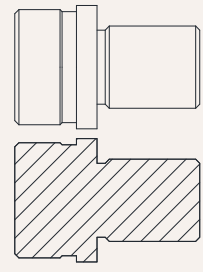

L1 = L shape, width 25mm, aperture 20.5mm

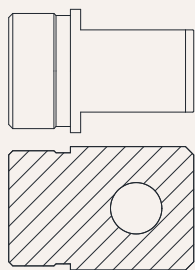

L2 =L shape, width 25mm, aperture 25.5mm

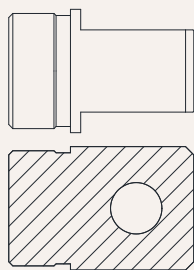

G1 = Spherical bearing, bore 20mm, model GS20

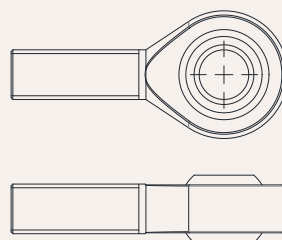

G1 = Spherical bearing, bore 30mm, model GS30

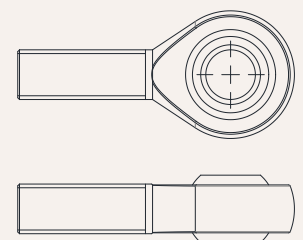

KZ = Customized

Power Cord Plug Type Code Table

1 = Bare wire

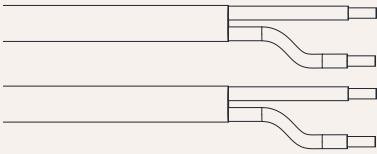

2 = O1 Straight plug

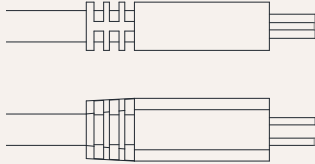

3 = 4-pin angled plug

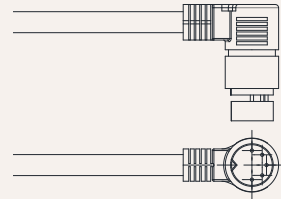

4 = 4-pin straight plug

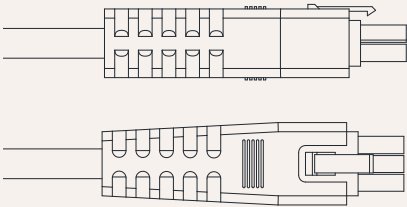

8 = Waterproof plug

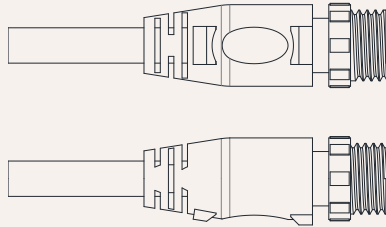

9 = 6-pin straight plug

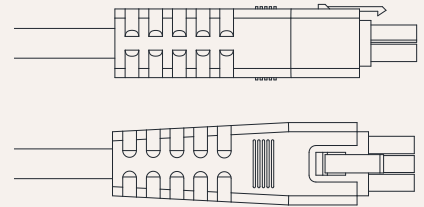

0 = Customized

Terms of Use

The user is responsible for determining the suitability of GeMinG products for a specific application.

GeMinG products are subject to change without prior notice.